

EUROSTER 4040TXRX

Wireless, programmable thermostat for all types of heating and air conditioning devices

MANUFACTURER: P.H.P.U. AS, Chumiętki 4, 63-840 Krobia, Poland

In order to take full advantage of thermostat capabilities please read this installation and operation manual carefully.

This manual is intended for 26.08.2019 version of thermostat.

1. THERMOSTAT APPLICATION

Euroster 4040TXRX is a state-of-the-art, wireless thermostat designed to control temperature in living and utility rooms. It is used to control the operation of CH boiler and other heating system components. It controls electrical equipment, floor heating and air-conditioning systems. Sensors used in **Euroster 4040TXRX** thermostats enable read-out and programming accuracy of 0.1°C. The thermostat operates with two temperature levels: comfort (day ☀) and economical (night ☾) temperature. Each temperature is modifiable within the range of 5 °C...35 °C. The thermostat is programmable in seven-day cycles with an accuracy of 0.5 hour, therefore it enables 48 temperature changes in 24 hours. It is possible to program different time ranges for each day of the week.

2. BASIC THERMOSTAT FUNCTIONS

- Does not require leading cable connections between the thermostat and the controlled device
- User-friendly thermostat enabling easy control of temperature in living and utility rooms
- Bidirectional communication ensures high operational reliability and resistance to interference
- Ability to cooperate with the maximum of 6 4040RX receivers
- Information on radio signal strength
- Clear, back-lit E Ink display
- Two temperature levels: comfort and reduced
- 0.5-hour accuracy of range programming
- Simultaneous display of current and preset temperature value
- Thermostat interlock with a selectable 4-digit code
- Numerous useful functions: temporary temperature setting, constant temperature, vacation mode, discharged batteries indication
- Temperature read-out accuracy of 0.1 °C
- Possibility to switch the thermostat off with an active frost protection temperature after the heating season
- Temperature reading correction
- Surface mounting

3. VISIBLE ELEMENTS OF 4040TX THERMOSTAT

BODY

- a) Operation mode switch:
 - In thermostat heating mode it switches the thermostat on and off
 - In thermostat cooling mode it switches between heating and cooling operation
- b) Thermostat control knob
- c) Display.

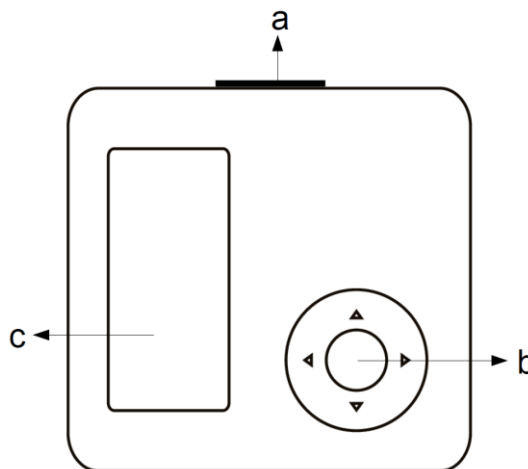

DISPLAY

- a) Current temperature
- b) Clock
- c) Preset temperature
- d) Displayed information
- e) Date and day of the week
- f) Current program symbol

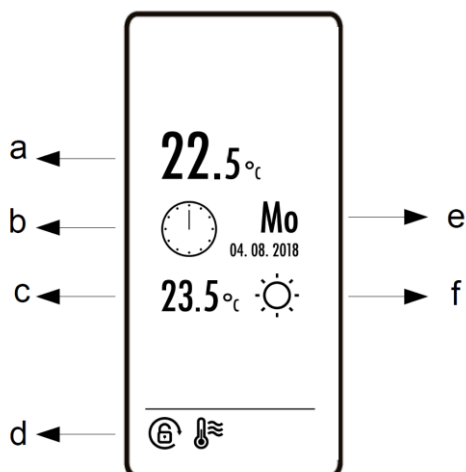

4. VISIBLE ELEMENTS OF 4040RX RECEIVER

- a) Switch activating continuous operation of the heating device
- b) Setting button with signaling LEDs
- c) Output cable.

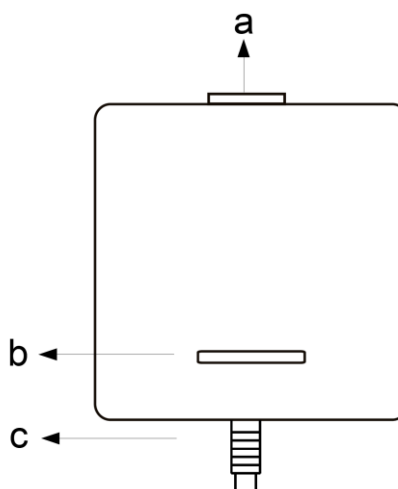

5. INSTALLATION

5.1. Safety rules

CAUTION!

- **Prior to the commencement of any installation works read this manual carefully! Incorrect installation and improper use may lead to serious hazards to users or other persons and result in property damage!**
- **Prior to mounting or dismantling the thermostat set make sure that the heating/cooling system is de-energized.**
- **Voltages hazardous to life may be present on the receiver output cables (power supply phase voltage), therefore only qualified technicians may install the thermostat!**
- **The electric connections performed and cables used shall be adequate to the applied loads and must conform to all requirements!**
- **Do not install the thermostat set in rooms with increased humidity; protect it against water and other liquids!**
- **Do not install any unit showing signs of mechanical damage!**
- **The thermostat is not a safety component. Additional protection devices must be used in systems prone to the risk of damage due to the failure of control systems!**
- **The device is not intended for use by children!**
- **Should there be any problem with proper operation of the thermostat, please contact your technician or the manufacturer!**

5.2. Proper place of installation

The thermostat is designed for indoor mounting. No cables are connected to the thermostat, thus it can be placed anywhere. In order to ensure fully efficient operation of the thermostat, please make sure that the following recommendations regarding the location of the thermostat are observed:

- Locate the thermostat at the height of approximately 1.5m above the floor.
- Avoid places with strong sunlight, near heating or cooling devices, situated directly by doors, windows and other similar locations, where the temperature measurement could be easily disturbed by external conditions.
- Avoid places with poor air circulation, e.g. behind furniture.
- Avoid moist places due to the negative effect of moisture on the service life of device.

5.3. Insertion and replacement of batteries

Place the batteries in the thermostat while observing the correct polarity. There are installation markings in the battery compartment. Then install (snap) the thermostat onto the base.

ATTENTION! Use only alkaline AAA batteries to power the thermostat. Do not use rechargeable batteries because their voltage is lower, and their effective time is shorter.

It is recommended to replace batteries before each heating season.

5.4. Sample Connection Diagrams

The following diagrams are simplified and do not cover all elements necessary for the correct installation.

In arrangement with a 230 V 50 Hz device

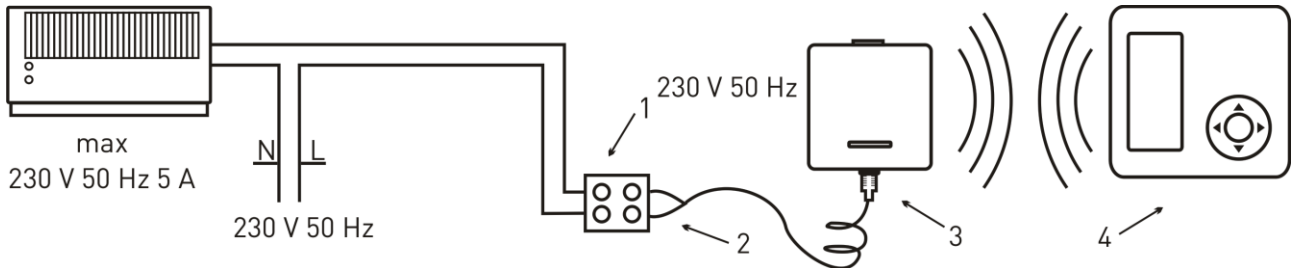

1. Electrical connection block
2. Output cable, using COM – NO contact (normally open)
3. Euroster RX (receiver)
4. Euroster TX placed in any room

In arrangement with a gas boiler

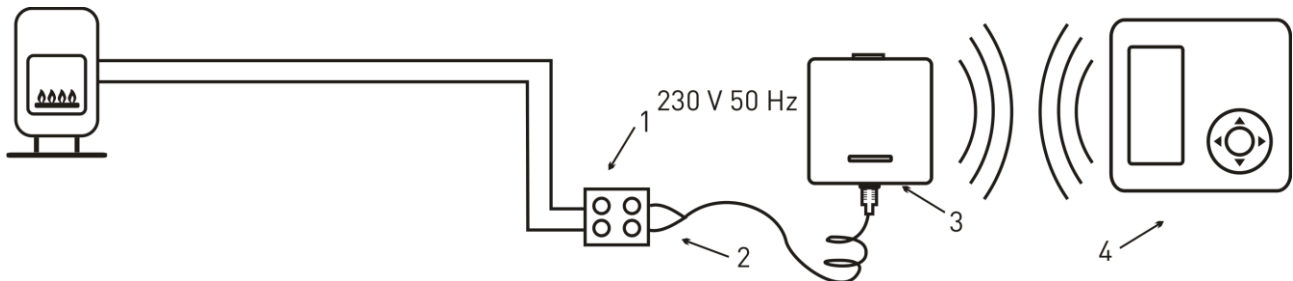

1. Electrical connection block
2. Output cable, using COM – NO contact (normally open)
3. Euroster RX (receiver)
4. Euroster TX placed in any room

6. USER SETTINGS

In this mode you may set basic parameters and select functions. Enter settings by pressing the central button. Use ▲▼ buttons to select the item you want to modify and press the central button again, then introduce changes and press ◀ to exit the menu. The introduced changes are stored.

6.1. Manual (one-off) temperature modification

Manual override function enables a temporary change of temperature without introducing changes in a program. The thermostat will operate according to the new temperature setting over the period of the current program. With the beginning of the subsequent program the manual override is completed, and the thermostat restores operation according to programmed temperatures.

In order to activate manual override, set the desired temperature using ▲▼ buttons. At this point manual override icon  is displayed. In order to finish the manual override earlier press ◀.

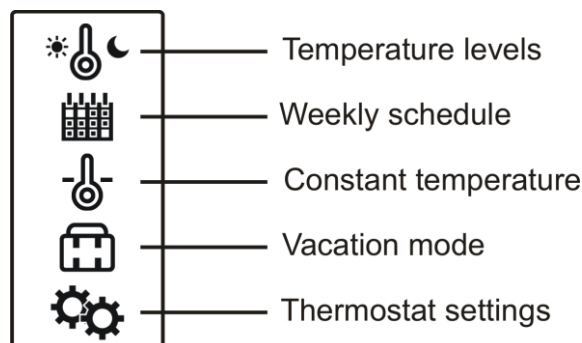

6.2. Temperature level modification

Two temperature levels are available in the thermostat: comfort temperature and economical temperature. These temperatures apply for all days of the week. Temperature values may be changed freely within the range of 5 °C...35 °C (in cabled sensor mode: 5 °C...85 °C). Factory settings are the following: comfort temperature 21 °C, economical temperature 20 °C.

In order to modify the temperature, go to menu, select  item, and use the central button to select the temperature to be modified. Use ▲▼ buttons to set the desired temperature. The longer the button remains pressed, the quicker the values change. Exit the menu by pressing ◀ or holding it for a few seconds.

6.3. Weekly program

Separate time period is provided for each day of the week. Select  item in the menu. Abbreviated names of weekdays are displayed. Use the central button to tick a day or individual days to be modified (if identical program is to be set for them). Use the right button to enter the time period.

Use the left button to set the time period for economical temperature and the right button to set the time period for comfort temperature. Whenever you press a button the temperature is programmed with a 0.5-hour period.

Use ▲▼ buttons to change only the time period of the range without changing the schedule, e.g. if it is necessary to correct the program. Confirm the introduced modifications with the central button. Exit the menu by pressing ◀ or holding it for a few seconds.

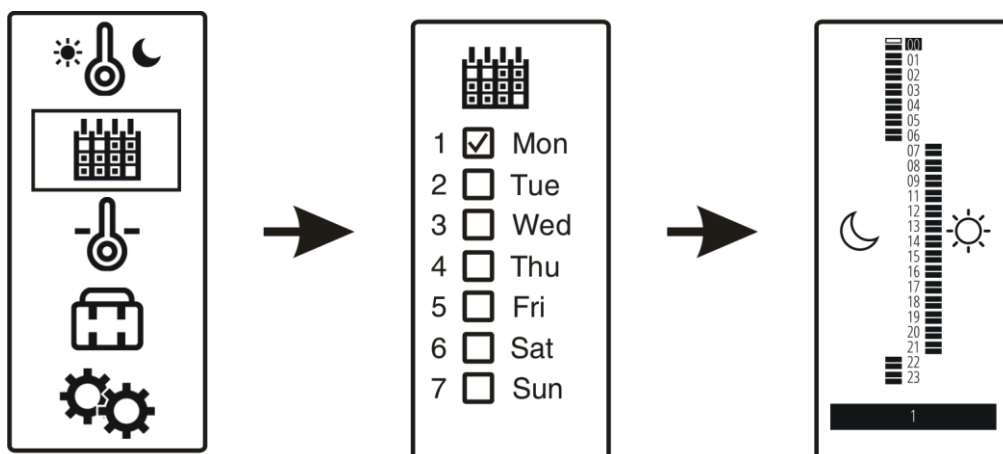

6.4. Temperature maintenance – constant temperature

The thermostat maintains the preset temperature regardless of the preset weekly program.

In order to activate temperature maintenance, go to menu and select . Use ▲▼ buttons to set the desired temperature. Confirm the entered temperature with the central button. Constant temperature icon is displayed. At this point the thermostat starts operating in constant set point mode. In order to restore operation according to weekly program, switch off the constant temperature function.

6.5. Vacation mode

Maintenance for a vacation period is used to set a desired temperature for the time of being away on vacation. It will allow you to significantly reduce heating system energy consumption.

In order to switch to vacation mode, go to menu and select . Use ▲▼ buttons to set:

- the year when the vacation commences; confirm it with the central button
- the month and day when the vacation commences; confirm it with the central button
- the hour when the vacation commences; confirm it with the central button
- the year when the vacation ends; confirm it with the central button
- the month and day when the vacation ends; confirm it with the central button
- the hour when the vacation ends; confirm it with the central button
- the temperature applicable throughout the entire vacation mode period.

Confirm the settings with the central button. Upon commencement of this mode vacation mode icon  is displayed.

6.6. TX THERMOSTAT SETTINGS

In this menu you may change and select the following functions:

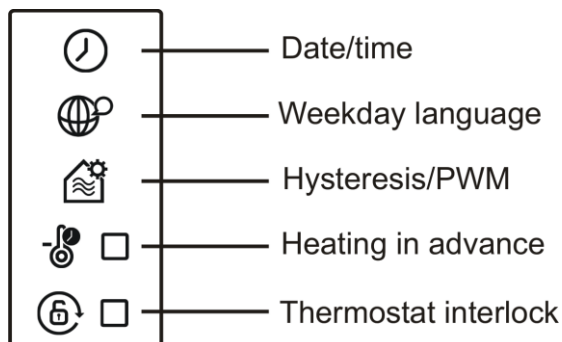

- **Date/time**



The date setting sequence is year > month > day. Using ▲▼ buttons select a year. Confirm with the central button. Set a month and day. Follow the same procedure to set hours and minutes.

- **Weekday language**

Thermostat may display weekdays in Polish, English or using universal symbols, where 1 stands for Monday, 2 for Tuesday, etc.

- **Hysteresis/PWM**

Two operational options of activating the heating (cooling) algorithm are available: hysteresis or PWM.

In the case of hysteresis, the device is activated based only on a difference between the preset and current temperature. In order to set hysteresis, go to menu and select , then select .

Use ▲▼ buttons to change the hysteresis value (the range is 0.2 °C... 10 °C; the factory setting is: 0.2 °C).



PWM ()^{PWM}, is a more advanced method to achieve the preset temperature. It is suited for systems with underfloor water heating. It is used to limit room temperature fluctuations. Unlike in on/off controls the current status of transmitter depends not only on the current difference between the preset and measured temperature, but also on the past changes of temperature. For example, if the measured temperature is lower than the preset temperature for a long time period, the thermostat switches the heating device permanently on. To activate this function, it is necessary to set three additional operation parameters:

- ✓ CPH – maximum number of cycles per hour (3-10). The thermostat calculates the number of switch-ons and switch-offs (cycles) per hour (according to temperature changes).
- ✓ CON – cycle duration period (2-10). It is the minimum period (minutes) for which the thermostat switches the transmitter on each time.
- ✓ PB – control band width (0.5 °C...3 °C). If the difference between the preset and measured temperature is included in proportional control band, then the thermostat selects the switch-on and switch-off times. Outside of this band the output is in continuous on or off operation.

- **Heating in advance**

Activating this function results in switching the heating on earlier in order to obtain the preset temperature at the required time. The time of advance in switching the heating on is calculated with an advanced algorithm, taking into account previous room heat-up times and the current temperature read-out. It takes the thermostat several days to calculate times for various temperatures correctly. To activate this function, go to thermostat menu and select .

- **Thermostat interlock**

The thermostat features a setting interlock function. A four-digit code of your choice may be entered. In such case it is not possible to change the settings. A setting interlock does not affect the thermostat operation. To activate the interlock, go to setting menu and select , then use ▲▼ keys to enter your code. Active interlock is indicated by displaying  icon. Follow the same steps to unlock the thermostat. This function is not active by default.

6.7. SERVICE SETTINGS

Service menu permits thermostat configuration according to the type of system. We suggest that you exercise special prudence when modifying these settings, because inappropriate settings may result in improper functioning of the system or in extreme cases lead to damaging system components.

In order to enter service settings press and hold for 5 seconds two buttons – the central and right button. The window presented below is displayed. The service settings are unavailable when the thermostat is switched off or batteries are discharged. Navigate the menu the same way you did in previous windows. The service menu consists of the following elements:

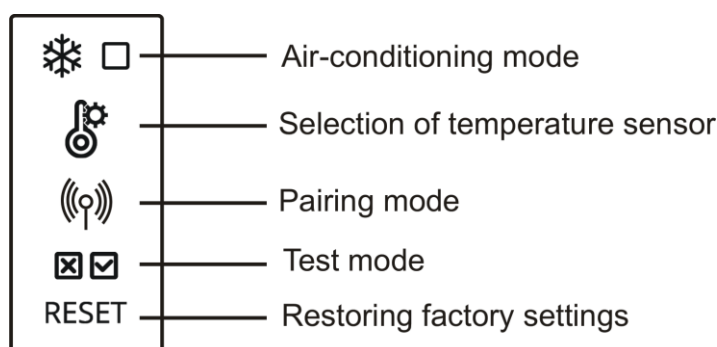

- **Air conditioning**

Having selected air-conditioning mode, the device connected to the thermostat will be switched on when the temperature increases above the preset level.

In air-conditioning mode, the function of thermostat power switch changes and the switch is used to select between heating and cooling. Activating the air-conditioning operation enables the preset ranges to be replaced with different ones – the ranges stored for cooling. Returning to heating functions restores the previous ranges. This function enables the thermostat to operate with air-conditioning and heating without losing the settings. The icon of switched-on device also changes – .

- **Selection of temperature sensor**

This option permits the selection of temperature sensor to cooperate with the thermostat. There are three operation modes available:

- ✓ the thermostat measures and maintains the temperature based only on internal sensor operation
- ✓ the thermostat measures and maintains the temperature based only on the measurements of external (cabled) sensor
- ✓ the thermostat measures the temperature of both sensors; it maintains the temperature of an internal sensor, and the external sensor acts as a temperature limit. Having selected this operation mode set the floor temperature limit value. This parameter is used to establish the maximum safe floor temperature. When the preset temperature is reached, the device gets switched off.
- ✓ Temperature sensor correction. It is used to adjust the temperature read-out within the range of +/- 5 °C. The function is convenient if the thermostat is located in a slightly warmer or cooler area of the room. Press the central button to introduce a change. Use ▲▼ buttons to set the new value. Confirm with the central button.

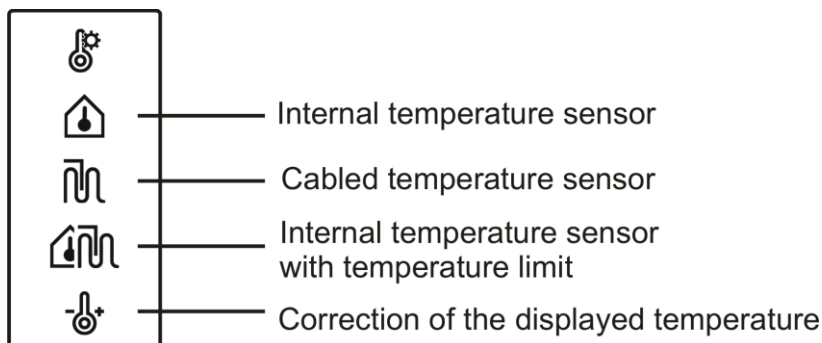

CAUTION! The floor temperature sensor is not included in the basic kit. Please order it separately. Connecting the sensor requires changing the thermostat basis, therefore the thermostat must be wall mounted.

- **Pairing mode**

Used to establish radio connection between the thermostat and the receiver (receivers). Pairing mode see point 8.1.

- **Test Mode**

In the test mode you may check the main parameters of the set such as:

- ✓ program version and compilation date
- ✓ operation of the RX receiver's transmitter – use ▲ button to change the status of the transmitter
- ✓ internal sensor temperature measurement
- ✓ cabled sensor temperature measurement (if installed)
- ✓ operation of the back-light – use ▼ button to switch on/off
- ✓ light sensor test
- ✓ The strength of the radio signal between the thermostat and the receiver (transmission and reception).

- **Reset**

By selecting and confirming this item you restore the thermostat factory settings.

7. ERROR INDICATION

 – no sensor, sensor short-circuit or damage

 – discharged batteries icon

 – no radio communication

8. RX RECEIVER SETTINGS

8.1. Connecting 4040TX thermostat with 4040RX receiver or 4040RX receivers (pairing)

Each thermostat and each receiver have a unique number distinguishing it from other ones. It is not possible for any thermostat not paired with the particular receiver to interfere with the operation of another pair or set.

The thermostat may be paired with other receivers at any time. A blackout, battery replacement as well as a complete reset of all thermostat settings do not affect pairing of devices in any way.

The pairing procedure:

- enter service settings on the thermostat
- select pairing mode
- connect the receiver to a power socket
- press the receiver button 3 times – the blue LED will switch on
- when the receiver is found "1" (the first receiver) is displayed
- should only one receiver be used, press the central button and exit the menu. The pairing mode is complete.

If you intend to pair several receivers (maximum 6) take the following steps:

- after finding the first receiver ("1" displayed)
- connect the second receiver to a power socket
- press the receiver button 3 times – the blue LED will switch on
- when the receiver is found "2" (the second receiver) is displayed
- Follow the same procedure to connect the subsequent receivers, then press the central button and exit the menu.

Caution! The pairing mode is available for 10 minutes after connecting the receiver to the mains!

Factory-established pairs are paired, however pairing may be repeated if necessary.

8.2. Selection of operating mode

Hold the button pressed and simultaneously connect the receiver to a power socket. Depending on the preset mode a green or red LED will switch on. The operation mode is changed every time the button is pressed. When the mode is selected the receiver restores operation.

Green – normally open mode (COM – NO). It is the mainly used operation mode. While the device operation indicator is active, output cables are shorted.

Red – normally closed mode (COM – NC). While the device operation indicator is active, output cables are opened.

Caution! Normally open mode (COM – NO) is a factory setting.

9. FIRST START

After being connected to the power socket, the receiver signals the transmitter operating mode. Flash of the green LED – normally open mode (COM – NO); flash of the red LED – normally closed mode (COM – NC).

Each change of status of the thermostat (switch-on/off of the heating) is completed by the receiver immediately, whereas the signal confirming the reception of the receiver's radio signal is repeated every 15 minutes.

9.1. Radio signal strength

Information on radio signal strength is transmitted with the signal confirming the reception of the receiver's radio signal. The reception of radio signal is confirmed with green light. Three flashes of LED stand for a very strong reception, two stand for strong reception and one flash stands for sufficient reception.

9.2. No radio communication

If the communication between the thermostat and the receiver is disrupted (e.g. due to discharged batteries) and such status lasts for 2 minutes (no reply from the receiver), then the receiver starts the frost-protection mode. The heating device will be switched-on every 3 hours for 20 minutes in order to prevent cooling of the rooms. When the communication is re-established (replacement of batteries), the receiver will switch the system off and automatically resume operation.

No radio communication is signaled with quick flashing of the green LED.

9.3. Continuous operation of the heating device (MAN)

In case of system failure heating may be switched on manually. Move the switch on RX receiver into the MAN position. The status is signaled with fast flashing of red LED (in heating mode) or blue LED (in cooling mode). Additionally, the "RX MANUAL" message is displayed at the thermostat display.

9.4. Receiver signal table

Function	Signaling
Pairing	Blue
Reception of radio signal	Green
No signal	Green – flashing
Heating device switch-on	Red
Manual mode in heating mode	Red – flashing
Air-conditioning device switch-on	Blue
Manual mode in air-conditioning mode	Blue – flashing

10. MAINTENANCE

Do not use solvents and aggressive detergents to clean the thermostat, since they may damage the surface of the housing and the display. Clean the thermostat housing with a soft cloth.

11. DIMENSIONS

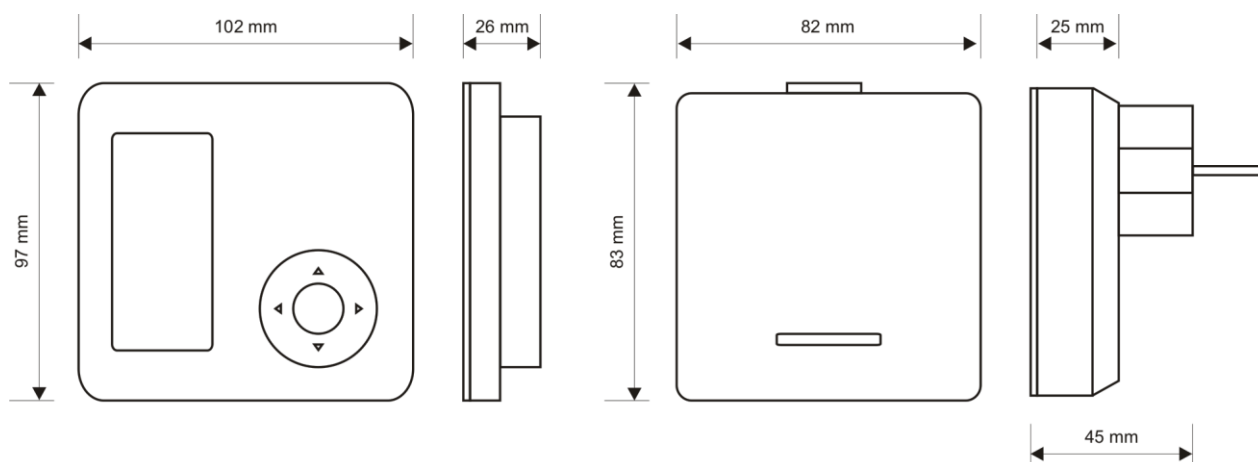

12. TECHNICAL DATA

Controlled device	heating / air conditioning systems
Supply voltage	3V (2 pieces of alkaline AAA batteries) / receiver – 230 V 50 Hz
Receiver output	relay, voltage-free type, SPST
Maximum load	5 A 230V 50 Hz
Temperature measurement range	0°C...+100°C
Temperature adjustment range	+5°C...+35°C
Temperature adjustment accuracy	0.1°C
Temperature reading accuracy	0.1°C
Hysteresis range	0.2 °C... 10 °C with 0.1 °C step of the change or PWM mode
Visual signalization	Back-lit E Ink display
Operation temperature	+5°C...+40°C
Storage temperature	-10°C...+50°C
Ingress protection rating	IP20
Color	white/gray
Mounting method	thermostat – stand / receiver – 230 V 50 Hz socket
Weight	Thermostat weight without batteries – 115 g Receiver – 170 g
Warranty period	2 years
Frequency of operation	868MHz
Maximum power of transmission	< 25 mW
Thermostat class	IV (PWM mode)
Thermostat contribution to the seasonal energy efficiency of room heating	2% (PWM mode)

13. KIT CONTENTS

- **Euroster 4040TX** thermostat
- **Euroster 4040RX** receiver
- 2 pieces of alkaline AAA batteries
- thermostat stand
- Installation and Operation Manual with Warranty Certificate

14. SIMPLIFIED DECLARATION OF CONFORMITY

P.H.P.U. AS AGNIESZKA SZYMAŃSKA-KACZYŃSKA hereby represents that the type of EUROSTER 4040 TXRX equipment conforms to the following directives: 2014/35/EU (LVD), 2014/30/EU (EMC), 2014/53/EU (RED), 2011/65/EU (RoHS).

The complete text of the Declaration of EU conformity is available at the following Internet address: www.euroster.pl

15. ELECTRONIC WASTE MANAGEMENT INFORMATION



This product is designed and manufactured from high quality materials and components suitable for reuse.

The crossed-out wheeled bin symbol located on the product (Fig. 1) means that the product is subject to selective collection in accordance with the provisions of the Directive 2012/19/EU of the European Parliament and of the Council.

The product contains batteries, which are marked with a crossed-out wheeled bin symbol (Fig. 1). The batteries are subject to the selective collection in accordance with the provisions of the Directive 2006/66/EC of the European Parliament and of the Council.

Such marking informs that the electrical and electronic equipment as well as batteries and accumulators may not be disposed of together with other household waste after their service life has ended. The user is obliged to take the used devices and batteries or accumulators to a point of collection of waste electrical and electronic equipment and batteries and accumulators. The entities collecting such equipment, including the local collection points, shops, and municipal entities, set up an appropriate system enabling handover of such equipment and batteries and accumulators. The proper disposal of waste equipment, batteries and accumulators contributes to prevention of consequences hazardous to the health of persons and nature, resulting from the possible presence of hazardous components in the equipment and batteries and from inaccurate storage and processing of such equipment and batteries.

Households play an important role in contributing to reuse and recovery, including recycling, of waste equipment. The attitudes influencing protection of the common good of clean environment are shaped at this level. Households are also one of larger users of small equipment and its rational management at this level impacts the recovery of recyclables. Inaccurate disposal of this product may be penalized in accordance with national legislation.

WARRANTY CERTIFICATE
EUROSTER 4040TXRX thermostat

Warranty terms:

1. The warranty is valid for 24 months from the device sale date.
2. Rights under the warranty shall be exercised within the territory of the Republic of Poland.
3. The claimed thermostat together with this warranty certificate must be supplied to the seller or directly to the manufacturer by postal services of Poczta Polska.
4. Warranty claims shall be processed within 14 business days upon the day when the manufacturer received the claimed device.
5. The device may be repaired exclusively by the manufacturer or by a party clearly authorized by the manufacturer.
6. Warranty becomes void in case of any mechanical damage, incorrect operation and repairs made by unauthorized persons.
7. This consumer warranty does not exclude, restrict nor suspend any right of the buyer if the product does not meet any of the sale contract terms.

.....
Sale date

Serial number /
date of manufacture

Stamp
and signature

Service:
Phone No.
(+48) 65-57-12-012

Business entity that issued this Warranty Certificate is:

P.H.P.U. AS Agnieszka Szymańska-Kaczyńska, Chumiętki 4, 63-840 Krobia, Poland